



Commercial Marine

WE MOVE YOU.
WITH RELIABLE
POWER.



A Rolls-Royce
solution



CONTENTS

01 Pioneering the Power that matters	04	06 Gensets	22
World-class power solutions and complete life-cycle support		Generating Power.	22
		Flexible power for lower life-cycle costs.	24
02 Commercial Marine augmented reality app	06	07 Ship Automation Systems	26
Innovative thinking — effective performance.		As comprehensive as necessary. As simple as possible.	28
03 System Solutions	08	08 More Power. Less emission	30
A lifetime of intelligent power.	10	E-Drive solutions	32
		Emission reduction technologies	34
04 Applications overview	14	09 Service	36
Propulsion systems tailored to your needs.	14	Service solutions designed around your priorities.	38
05 Core Technologies	16		
All engines at a glance.	18		



Augmented Reality:
Scan AR markers for
more information
and digital content.

Welcome to the Cutting Edge

PIONEERING THE POWER THAT MATTERS

01

Rolls-Royce provides world-class power solutions and complete life-cycle support under our product and solution brand MTU. Through digitalization and electrification, we strive to develop drive and power generation solutions that are even cleaner and smarter and thus provide answers to the challenges posed by the rapidly growing societal demands for energy and mobility. We deliver and service comprehensive, powerful and reliable systems, based on both gas and diesel engines, as well as electrified hybrid systems. These clean and technologically-advanced solutions serve our customers in the marine and infrastructure sectors worldwide.

A solution provider

MTU systems power the largest yachts, the strongest tugboats and the biggest land vehicles and provide energy for the world's most important mission-critical applications. Through advanced solutions such as microgrids, we integrate renewable energies and manage the power needs of our customers.

Our customized service offerings help you maximize uptime and performance and are supported by our digital solutions, which enable remote monitoring, predictive maintenance and a range of other benefits that keep your systems running at their best.

For over 110 years, we have provided innovative power solutions for our customers – meeting even the most demanding drive requirements. Our products and services span a wide range of applications and power needs, with both standard and customized options.

An expert in technology

As part of Rolls-Royce, we have long been known for cutting-edge innovation and technological leadership in product development. That same spirit of innovation inspires our sustainability efforts. Our focus is on developing and implementing system solutions that both maximize efficiency and reduce emissions -- which in turn work to reduce our impact on the environment.

A passionate and reliable partner

We at Rolls-Royce spend every day working together with our customers, to deliver engines, systems and complete life-cycle solutions that best fit your needs. We understand that each

application is different and has its own specific demands. Our engineers embrace the challenge of finding the perfect solution for your unique power requirements. Every step of the way – from project planning, through design, delivery and commissioning; to the lifetime care of your equipment – we are dedicated to helping you get the most from your MTU investment.

1 OIG Giant II
6x 12V 4000 P83

2 FRS Halunder Jet Helgoland Katamaran
16V 4000 M63L

3 Fairplay IX
2 x 16V 4000 M63L

Commercial Marine augmented reality app.

INNOVATIVE THINKING – EFFECTIVE PERFORMANCE.

02

Experience our drive solutions interactively – with augmented reality techniques. All you need is a smartphone or tablet on which to run our app. And you can dive into the future of innovative propulsion technology. Get to know our solutions with videos, images, infographics and 3D models. Find out how it works in just a few steps.

Three different ways to install the app on your smartphone:

- Scan the QR code on this page
- Search for “MTU Commercial Marine” on Android Play Store or Apple App Store
- Type in the link on your smartphone www.mtu-online.com/marine-ar

Once the app starts, it will show you the basic handling before it switches to our AR Viewer.

- Each page containing the AR Symbol has additional content offering more information on the subject.
- Some of the content is interactive: it can be clicked on-screen to display the additional information.
- You do not have to carry this document around with you. Our content will be available without it: simply navigate to the burger menu and access the respective areas such as videos.
- Some of the content can be downloaded from the web.
- If you require additional information, the app contains a contact form for the purpose.



Scan QR code to activate augmented reality features.



The meaning of the icons you find in the app:



You can watch a video



You can download the PDF



You can rotate the item 360°



Some additional information is available



PULLING MORE THAN
100,000 TONS OF STEEL
TAKES MORE THAN
A POWERFUL ENGINE.

03

System Solutions.

A LIFETIME OF INTELLIGENT POWER SOLUTIONS.

Planning

We supply a complete propulsion concept. Our engineers provide extensive analysis, documentation and risk mitigation services, as well as integrated mechanical, electrical and electronic interfaces.

Integrated Automation System

Our Integrated Automation Systems like BlueVision or MTU SmartBridge allow operators to monitor and control the whole propulsion plant, the on-board power supply and the entire vessel. Our Automation Systems are versatile, user-friendly and modular.

Propulsion System Integration

We provide comprehensive engineering and technical support for the design and implementation of a vessel's propulsion system. Our application engineering team helps reduce design, installation and commissioning costs.

Propulsion Systems

MTU engines and propulsion systems are characterized by high power density, low weight, compact design, and mechanical and thermal robustness, as well as simple operation, straightforward maintenance and low life-cycle costs.

Refits

Refurbishment of propulsion and automation systems is a cost-effective way to preserve and improve valuable vessels. Our service include the supply of equipment, planning and implementation of the entire refit.

ValueCare services

MTU ValueCare ensures maximum performance and lasting value, with a complete portfolio of service and support solutions including analysis, spare parts, training, technical documentation and full logistical support.



Overview

PROPULSION SYSTEMS TAILORED TO YOUR NEEDS.

04

Offshore wind park crew boats, service and supply vessels

With its long-standing, strong commitment to the marine sector, We have always felt a particular responsibility for the environment – and have lived up to that responsibility in all aspects. That's what makes us the ideal partner for companies active in similar, forward-looking sectors – such as power generation from renewables



Coastal cargo, inland cargo and pusher towboats

Your competitive position and financial success depend on reliable, timely operation. We provide the foundation for this with high quality products, preventive maintenance programs, 24/7 service and as a result, maximum uptime.

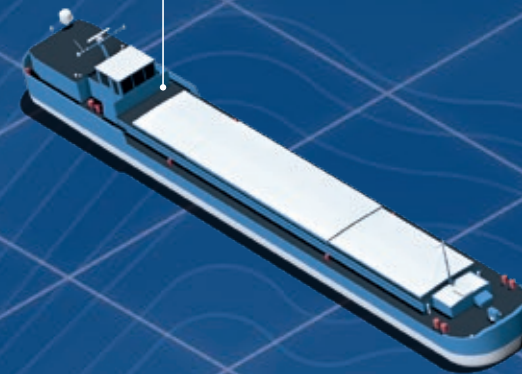

Tugboats

Harbor and escort tugs must maneuver with high power, precision and speed in all situations. Our engines help you meet these requirements with broad performance maps, proven common-rail technology and sequential turbocharging. The result: impressive bollard pull figures.

Special vessels

From fire and rescue boats to research and survey vessels: No matter what specialized task your vessel performs, We can provide exactly the right propulsion solution – involving both high quality products and preventive maintenance programs for the highest level of reliability.



Offshore service and supply vessels

No matter how rough conditions are at sea: You have to get out there, and your vessels' availability must be guaranteed. So what you need are propulsion systems that are 100 % reliable, punctual and safe. We make sure they are: with engines braving even the harshest conditions, with preventive maintenance concepts designed for continuous heavy duty service and, with comprehensive support 24/7.



Pilot boats

No matter how rough the sea state, ships have to be guided to harbor, so your vessel's availability must be beyond doubt. You need propulsion systems that are safe, powerful and fully reliable. We make sure your engines can brave even the harshest conditions.



Special vessels

From fire and rescue boats to research and survey vessels: No matter what specialized task your vessel performs, We can provide exactly the right propulsion solution – involving both high quality products and preventive maintenance programs for the highest level of reliability.



Passenger vessels and ferries

Reliable operation of your fleet is a crucial factor in the success of your business. We lay the foundation by supplying high-quality products and delivering preventive maintenance programs designed to ensure continuous heavy-duty service. You can rely on our 24/7 service – and on securing maximum uptime for your vessel.



DECISIVE ACTION REQUIRES
A STRONG HEART.

05



ENGINE ROOM



Core Technologies

ALL ENGINES AT A GLANCE.

For decades, thousands of our engines have been at sea, in rivers and lakes around the world. They perform reliably and efficiently as main or ancillary drive systems and provide energy as on-board power supply systems. Their performance, power and reliability has been proven time and time again.

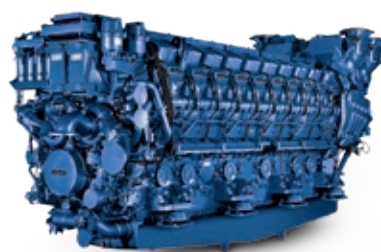

Series 8000
The most powerful highspeed engine for the very highest demands



Series 1163
The proven, evolved engine for the marine industry



Series 4000
One of the most successful heavy-duty engines ever

Analytics

We use the most diverse analysis and simulation tools to develop state-of-the-art propulsion solutions. These include vibration analyses, component strength verification and dynamic response simulations of entire propulsion systems.

Electronics

The latest generation of our electronic management system, ADEC (Advanced Diesel Engine Control) controls key systems such as fuel injection and turbocharging that affect engine consumption and emission levels as well as performance.

Fuel injection

We optimize fuel combustion in the cylinder by means of its electronically controlled common rail fuel injection system in combination with other technologies such as turbocharging.

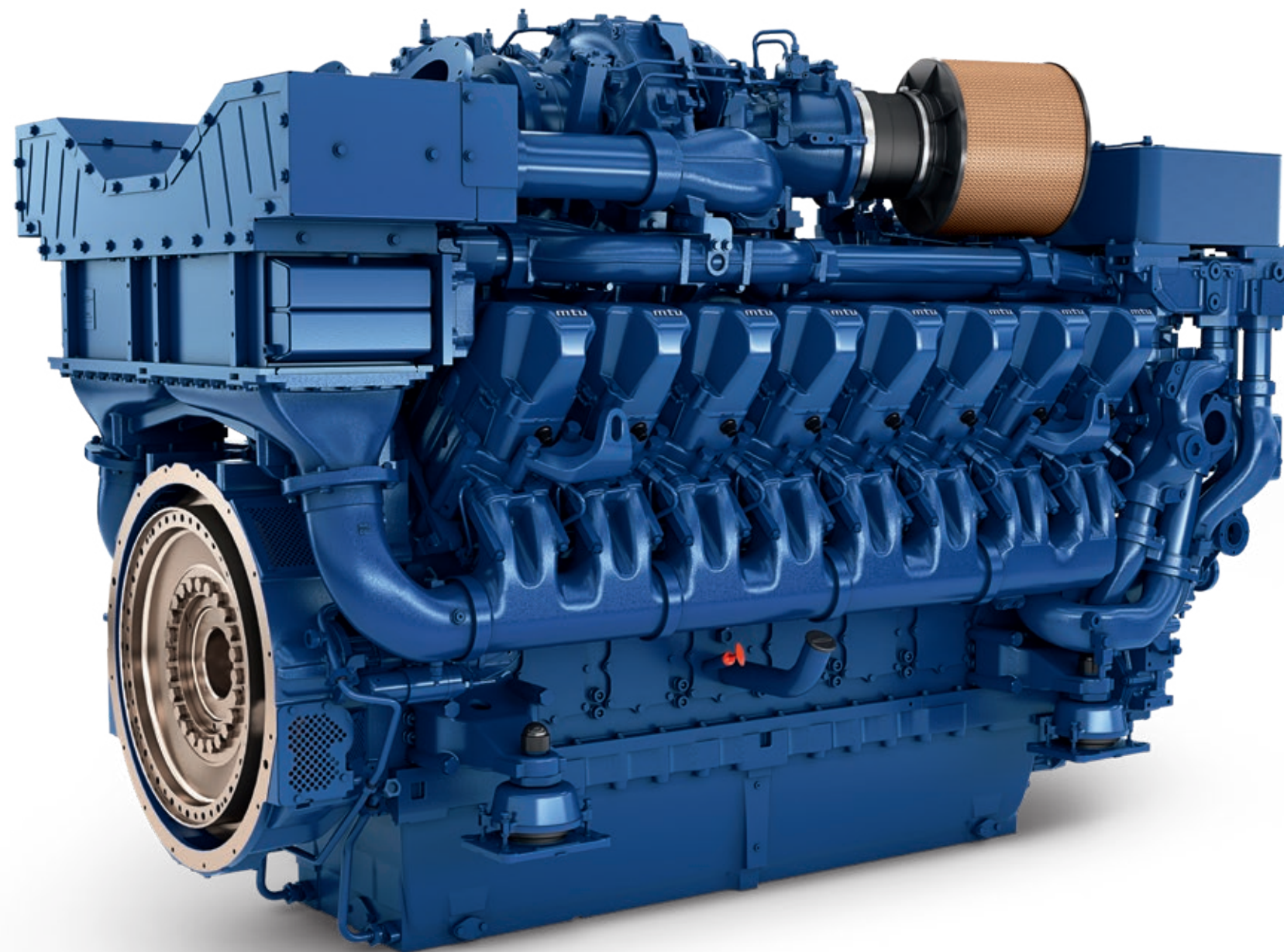

Aftertreatment

As installation space is always restricted inside the engine room, our inhouse developed airless SCR (Selective Catalytic Reduction) solution is compact and maintenance friendly.

Turbocharging

We develop and produce its own turbochargers for high-performance applications. Turbocharging helps achieve low fuel consumption and high performance across a broad range of running speeds.

Alternative fuels

We have based the design of our pure gas engine on our legendary IRONMEN engines. The new design will feature multipoint gas injection, dynamic engine management and an advanced turbocharging, and will match the performance of a modern diesel.

Mountings

Our engines are installed on special rubber mountings to reduce the transmission of structure-borne noise to the vessel's hull. Double resilient mountings are available as an option, and assist the single resilient mountings in achieving even more effective noise reduction.



Series 60
Uncompromising engine uptime



Series 2000
The powerful heart for maximum agility

Generator Sets.

GENERATING
POWER.

06

We offer a complete genset portfolio for commercial applications - from 5 to 2,700 kW - for auxiliary and emergency power generation and diesel-electric propulsion. Obtainable as 50/60 Hz versions, our gensets feature numerous options and accessories such as soundshields, control panels, PTOs for fire fighting pump drives, etc. High uptime and long TBO of up to 42,000 hrs ensure economical operation and reliable performance.

As a system supplier specializing in generator sets and automation systems, we configure complete propulsion solutions, implementing the best possible technologies for your needs. From cost-efficient pre-engineered standardized gensets designed and qualified by our central engineering headquarters in Germany to customized, advanced solutions as well as variable speed gensets - our quality and reliability have been proven in the field, all over the world, for decades.

Available for prompt delivery, our constant-speed gensets are easy to configure thanks to their modular design. This helps shorten project time frames while enabling our global network of partners and distributors to provide complete genset solutions backed by our factory engineers. Local content requirements can be met by means of global component sourcing and worldwide manufacturing options.

Our customers benefit from our one-stop shop philosophy and our commitment to comprehensive service and support, provided through our global 24/7 customer assistance center and service network comprising over 1,200 locations worldwide.

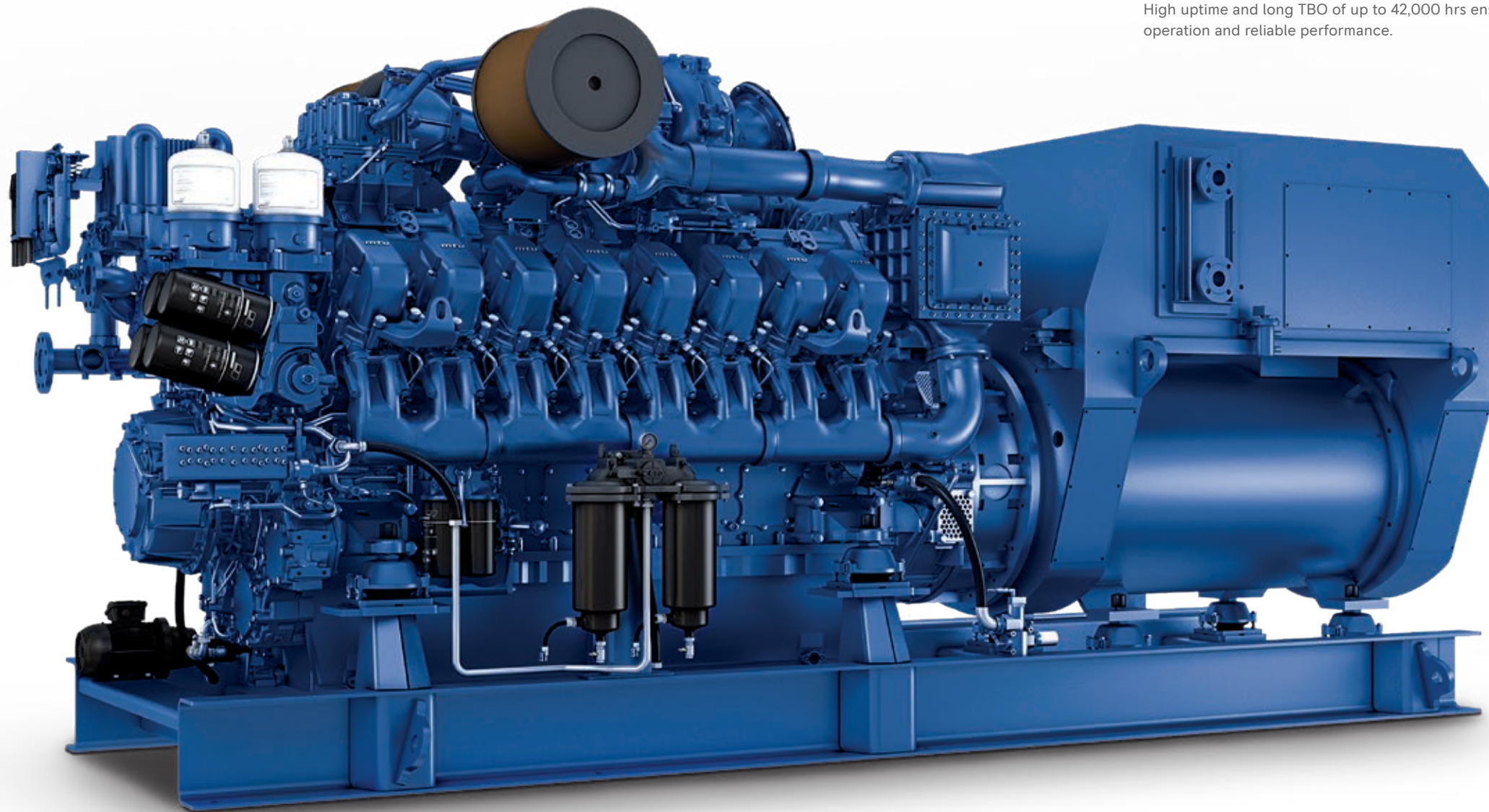

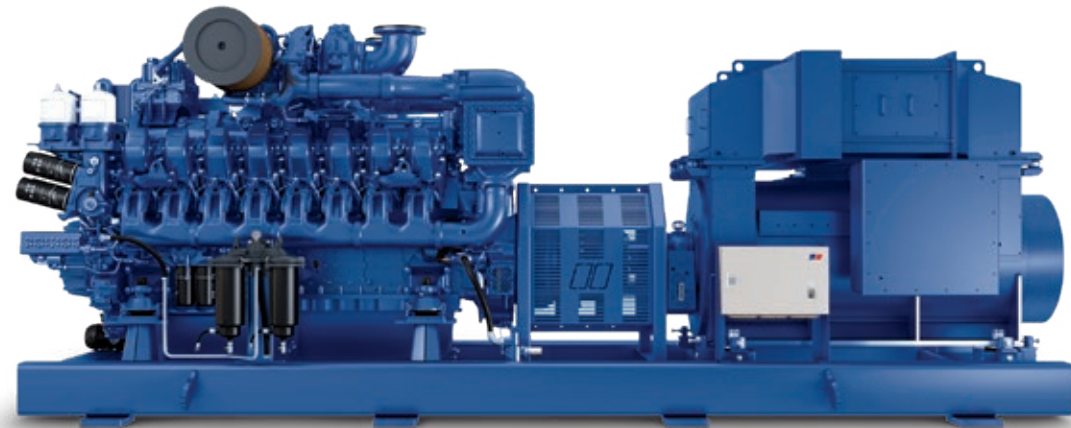
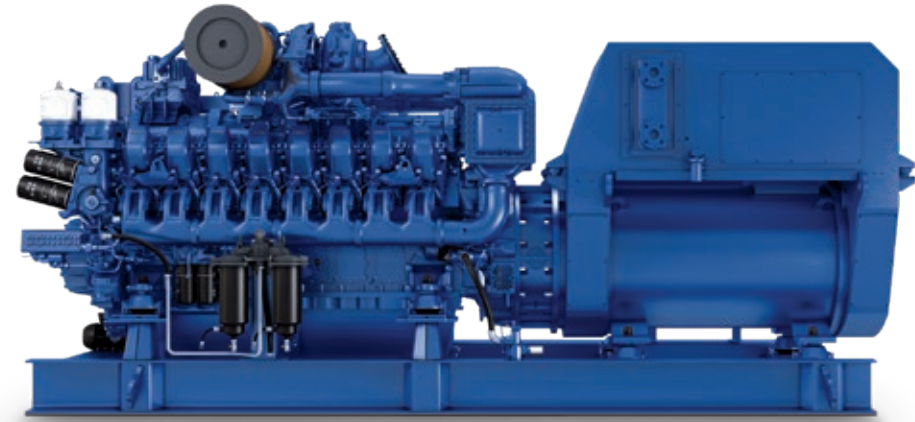

Generator Sets.

FLEXIBLE POWER FOR LOWER LIFE-CYCLE COSTS.

Do you want a flexible system with advanced technology for super-efficient operation? Our variable speed gensets makes this possible, maximizing operational flexibility and minimizing operating costs. The patented Superior System Controller (SSC) determines the best operating point in the engine performance map in relation to the electrical power demand. And for customers who prefer to use a generator of their choice, we offer a precise simulation and calculation to ensure safe, economical operation.

- Benefits:**
- Less fuel consumption at part load, up to 15%*
 - Longer maintenance intervals and up to 20%* lower maintenance costs
 - Lower noise signature

Flange-mounted or free-standing
We supply gensets with flange-mounted or free-standing generators on a common baseframe as per customer requirements.

- Flange-mounted benefits:**
- Cost effective solution
 - Compact design saves installation space and offers more room for cargo or crew
 - Easy service access inside the engine room

- Free-standing benefits:**
- Longest maintenance intervals based on sleeve bearings and maintenance-free, non-aging and heat resistant coupling
 - Easy in-vessel serviceability

Comparison of fuel consumptions

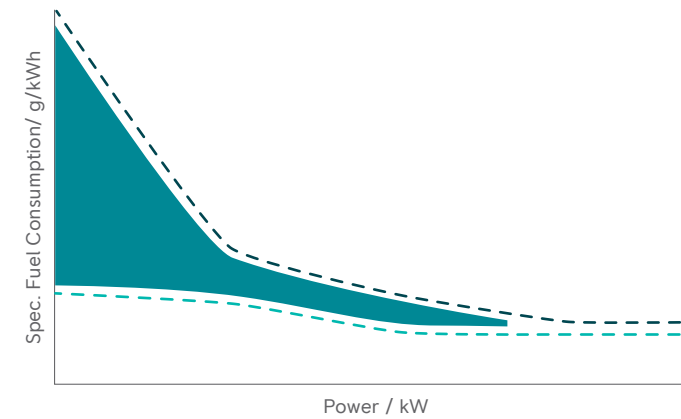

- Constant speed
- Variable speed
- Potential fuel saving

Rev counter showing variable range of RPM



POWER UNDER
CONTROL.

07

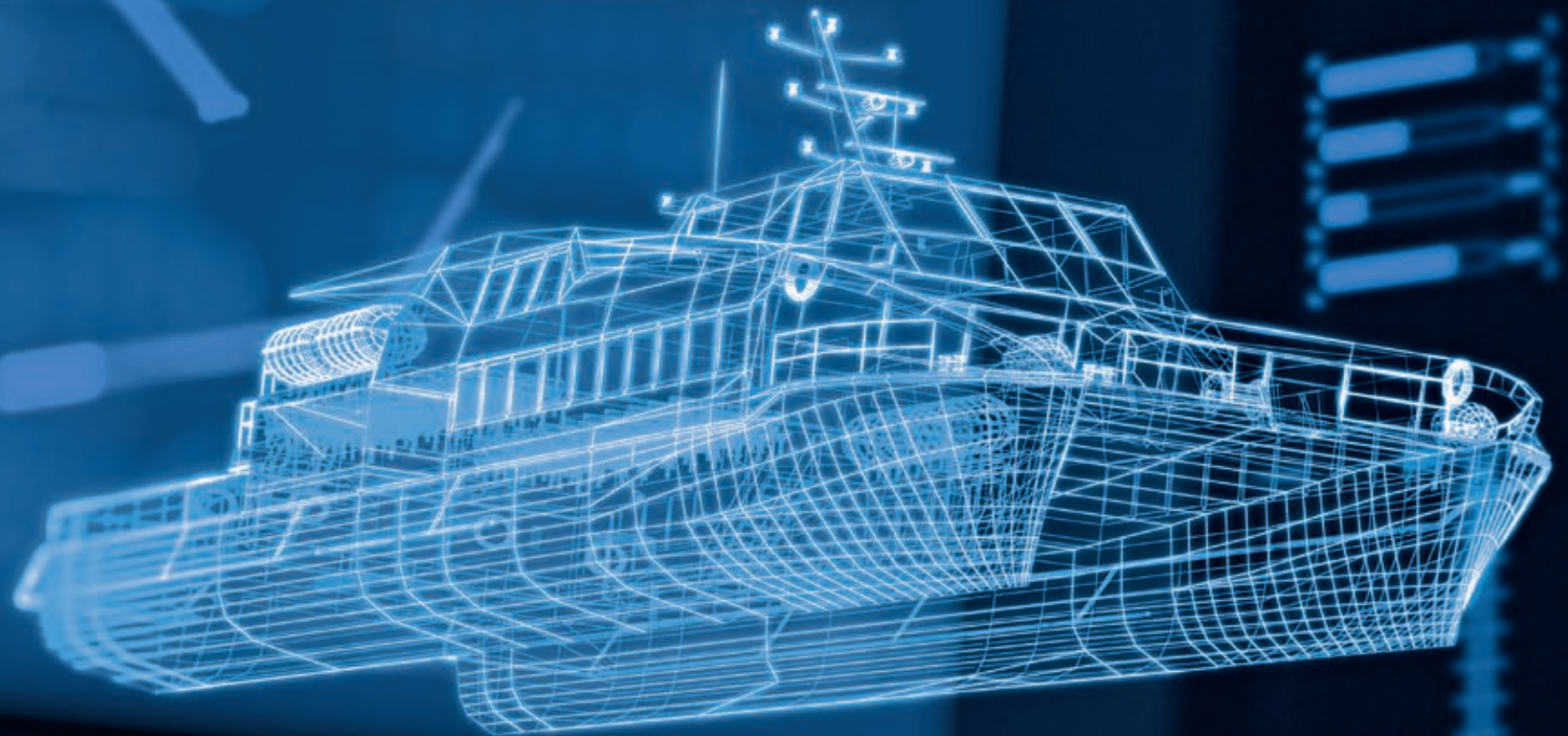

Ship Automation Systems

AS COMPREHENSIVE AS NECESSARY.
AS SIMPLE AS POSSIBLE.

Our standard automation systems are delivered ready for installation, perfectly matched to your propulsion system, giving you a complete package where everything is fine-tuned to your requirements: powerful engine performance, maximum efficiency, uncompromising reliability and green credentials.

BlueVision_Basic | NewGeneration

Our non-classifiable monitoring and propulsion remote control system for Series 2000 and 4000 engines incorporates a deliberately simple design offering full basic functionality. An elementary feature of BlueVision_Basic | NewGeneration is the compactness of its hardware. As the central system component, the Local Operating Panel (LOP) pulls together all basic functions available in this version, really simplifying installation, operation and diagnostics.

Key Features:

- Compact hardware for easy installation and commissioning
- Local Operating Panels (LOPs) with basic functionality such as start, stop, combined alarm/horn off, for installation in the engine room
- All control stand components installed throughout the ship are connected to the associated LOPs via CAN bus

BlueVision_Advanced | NewGeneration

Our classifiable monitoring and remote control system comprising a comprehensive standard automation system solution is available for Series 2000 and 4000 engines.

An elementary feature of BlueVision_Advanced | NewGeneration is the system bus. Data transmission between the LOP and the commanding control stands is performed via a redundant Ethernet-based field bus. This ensures totally secure communication and maximum flexibility of the overall system, also with an eye to future upgrades.

Key Features:

- Type-approved components such as LOP, control lever, display and instruments
- Designed to standards approved by all major classification societies
- Local Operating Panels (LOP) with color displays and advanced functionalities such as clutch and speed control
- Data communication via redundant Ethernet ring bus



MORE POWER.
LESS EMISSION.

08



E-Drive solutions

HIGHER PERFORMANCE. FEWER EMISSIONS.

For minimum emissions, lower operating costs and maximum ease of use, hybrid systems – such as E-Drive systems – are the preferred solution. Conventional E-Drive systems can be upgraded using optional battery modules, enabling silent, emission-free operations in harbor areas.

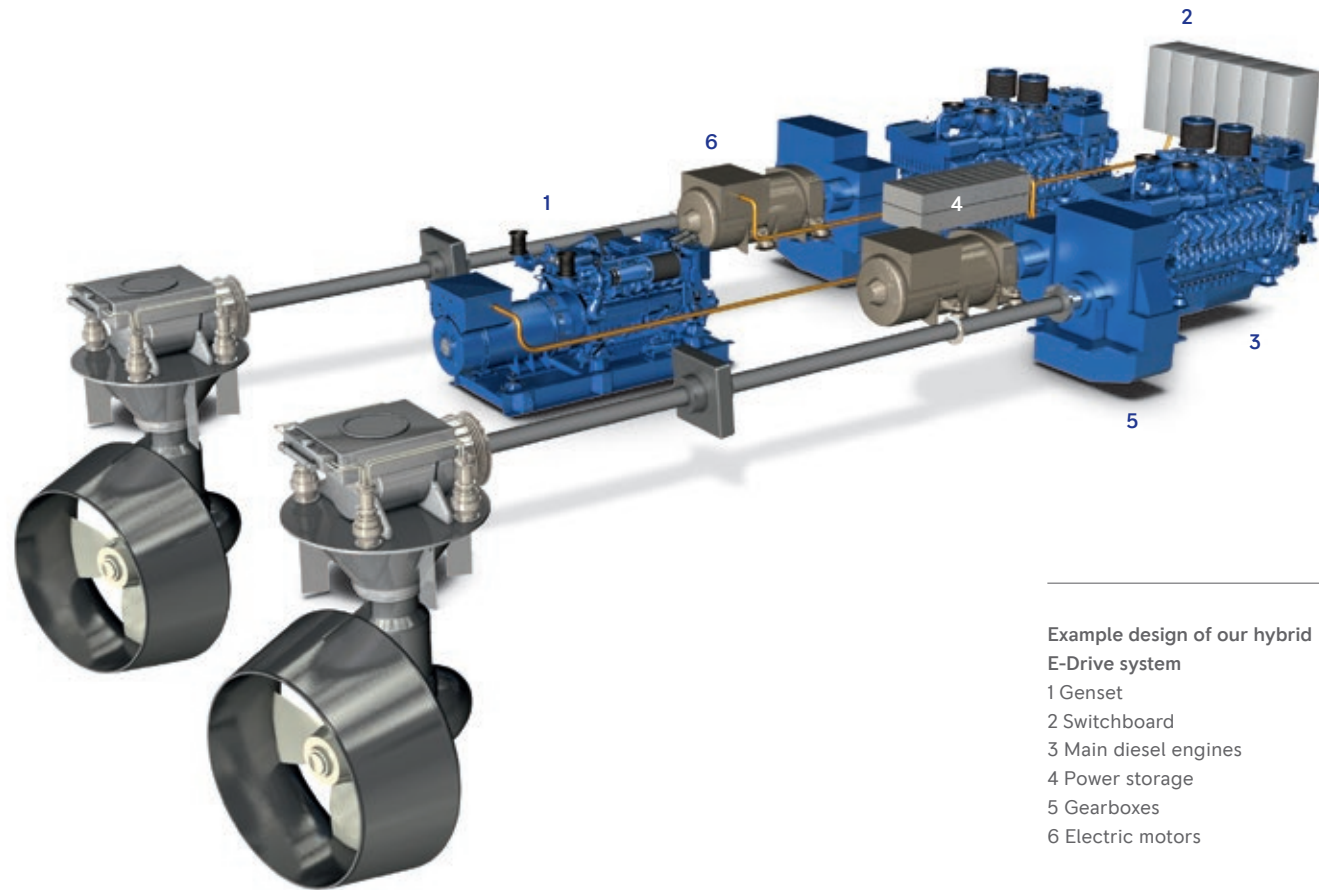

Example design of our hybrid E-Drive system
1 Genset
2 Switchboard
3 Main diesel engines
4 Power storage
5 Gearboxes
6 Electric motors

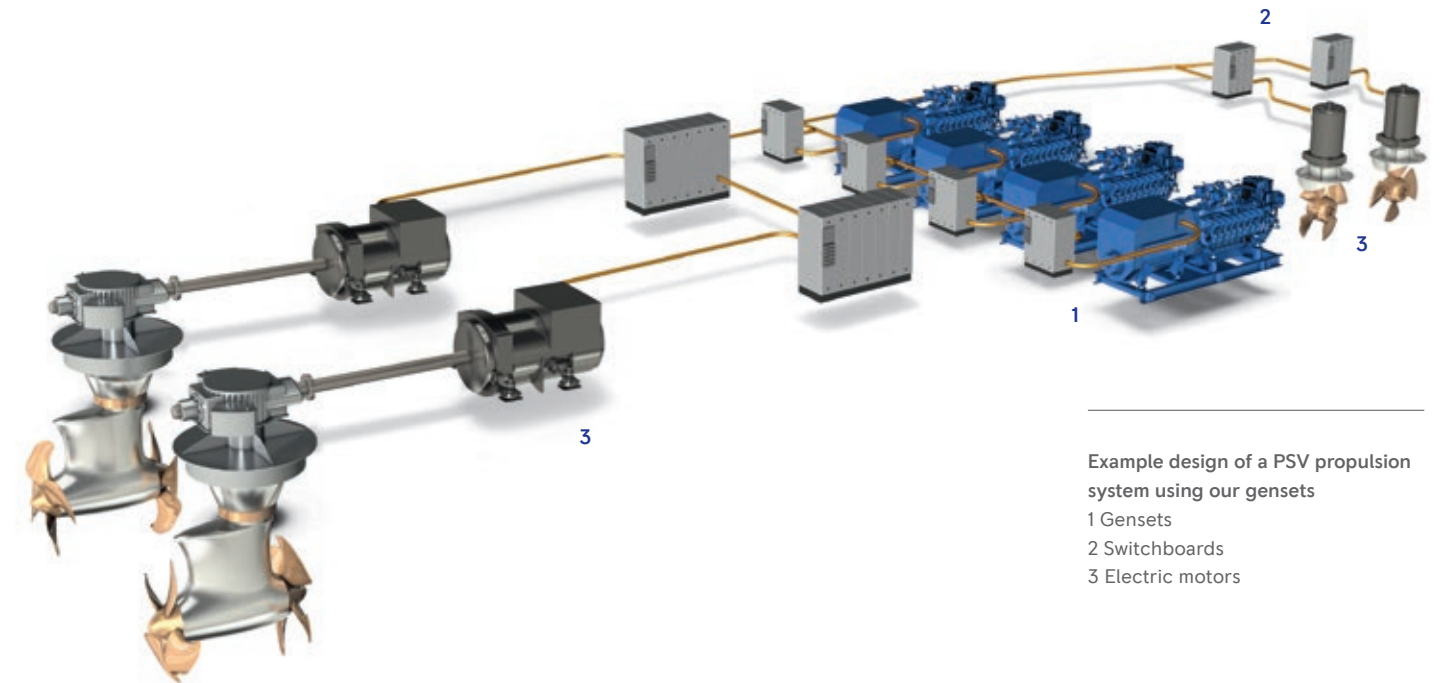

Example design of a PSV propulsion system using our gensets
1 Gensets
2 Switchboards
3 Electric motors

Innovative E-Drive solutions

Our MELT engineering (mechanical, electrical, logical and thermal system integration) helps manage the complexity of E-Drive systems. We design and supply customer-specific E-Drive systems including fully integrated automation systems based on the proven Series 2000 and Series 4000 marine diesel engines. While E-Drive propulsion systems require a higher initial investment than standard diesel-mechanical systems, they offer a number of benefits that provide outstanding return on investment.



Emission reduction technologies

WORKING WITH A
CLEAR CONSCIENCE.

Operating on the water means working in a sensitive environment. Assuming responsibility for protecting the water and air and keeping them clean is second nature to us. We have always played a leading role in developing environmentally friendly engines and, in particular, solutions for reducing emissions. Since we have all the relevant key technologies bundled within our company in addition to our core business of building engines, we have been and will always be leaders in this field. Our engines are an embodiment of the most state-of-the-art technology available.

SCR solution

As installation space is always restricted inside the engine room, the inhouse developed airless SCR (Selective Catalytic Reduction) solution from MTU is compact and maintenance friendly. Besides easily accessible doors for replacement of the SCR catalysts, the system also features an integrated mixing pipe and dosing units. The integrated mixing pipe and DEF (Diesel Exhaust Fluid) dosing allows the shipyard highly flexible pipework between the engine and the SCR box. Additional space to fit the exhaust gas aftertreatment is reduced to a bare minimum. Amonia slip is prevented under all operating conditions by a closed loop regulated control system.

Besides the exhaust emissions related features, our SCR system also reduces noise.

SCR – the ideal solution for the marine world

When using EGR (Exhaust Gas Recirculation) technology, the quality of the fuel is essential. Fuel with more than 15 ppm sulfur will lead to the formation of sulfur acid in the EGR cooling process. Sulfur acid will cause substantial engine failures over time. As many vessels operate worldwide, especially in the offshore service and supply business, MTU evaluates SCR as the preferred solution to maintain reliability of our engines and the safety of your vessel and crew. SCR technology allows operation with lower fuel quality.

Developing all major key technologies inhouse like, SCR, EGR, turbocharging and common rail fuel injection, means we are able to shape the ideal solution to meet IMO III and EPA Tier 4 emissions regulations.

At MTU we treat EGR as the ideal solution for applications like mining or oil&gas onshore, but within the marine world we are convinced that SCR technology grants much higher availability and component lifetime.

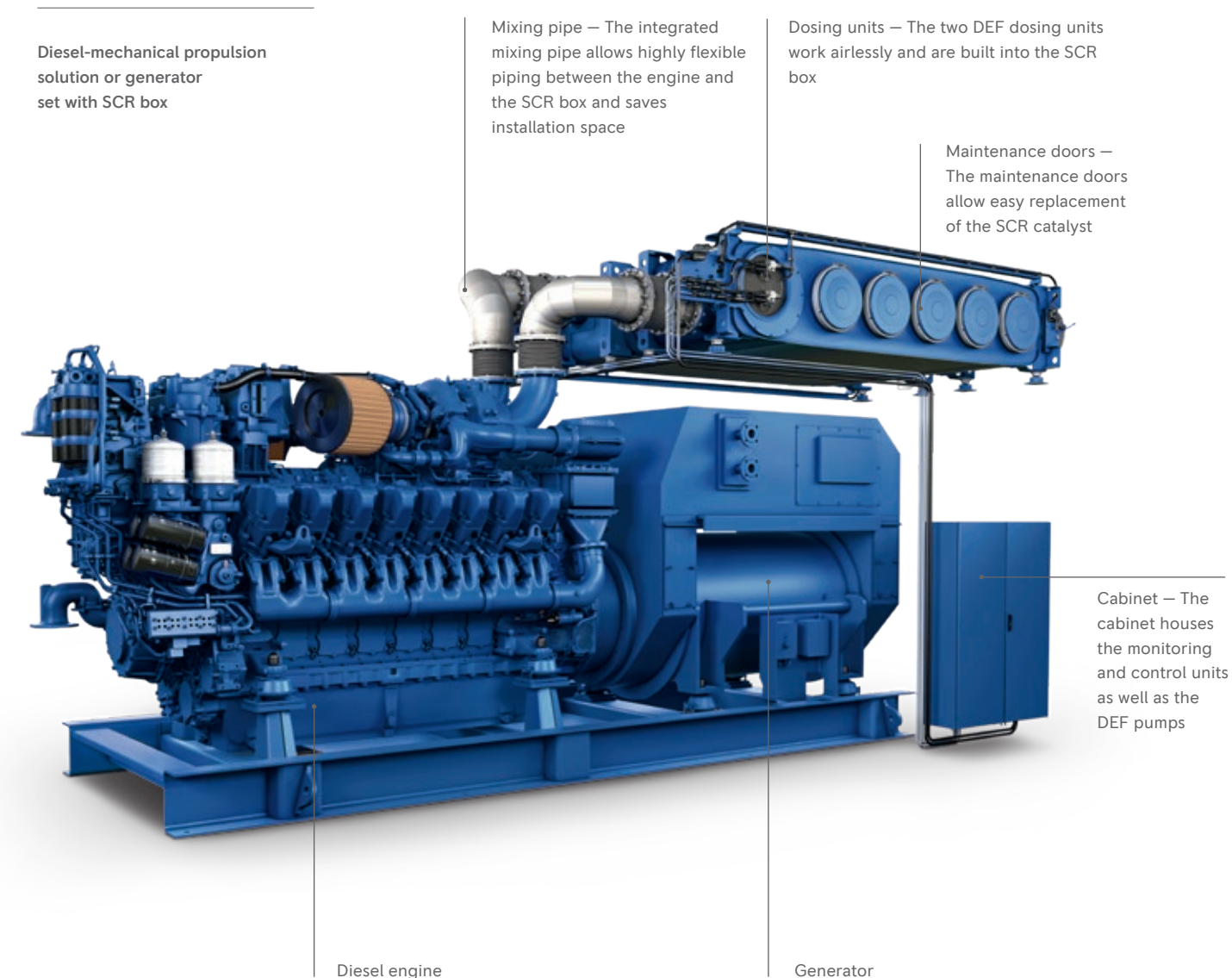



MORE UPTIME.
LESS STRESS.

09



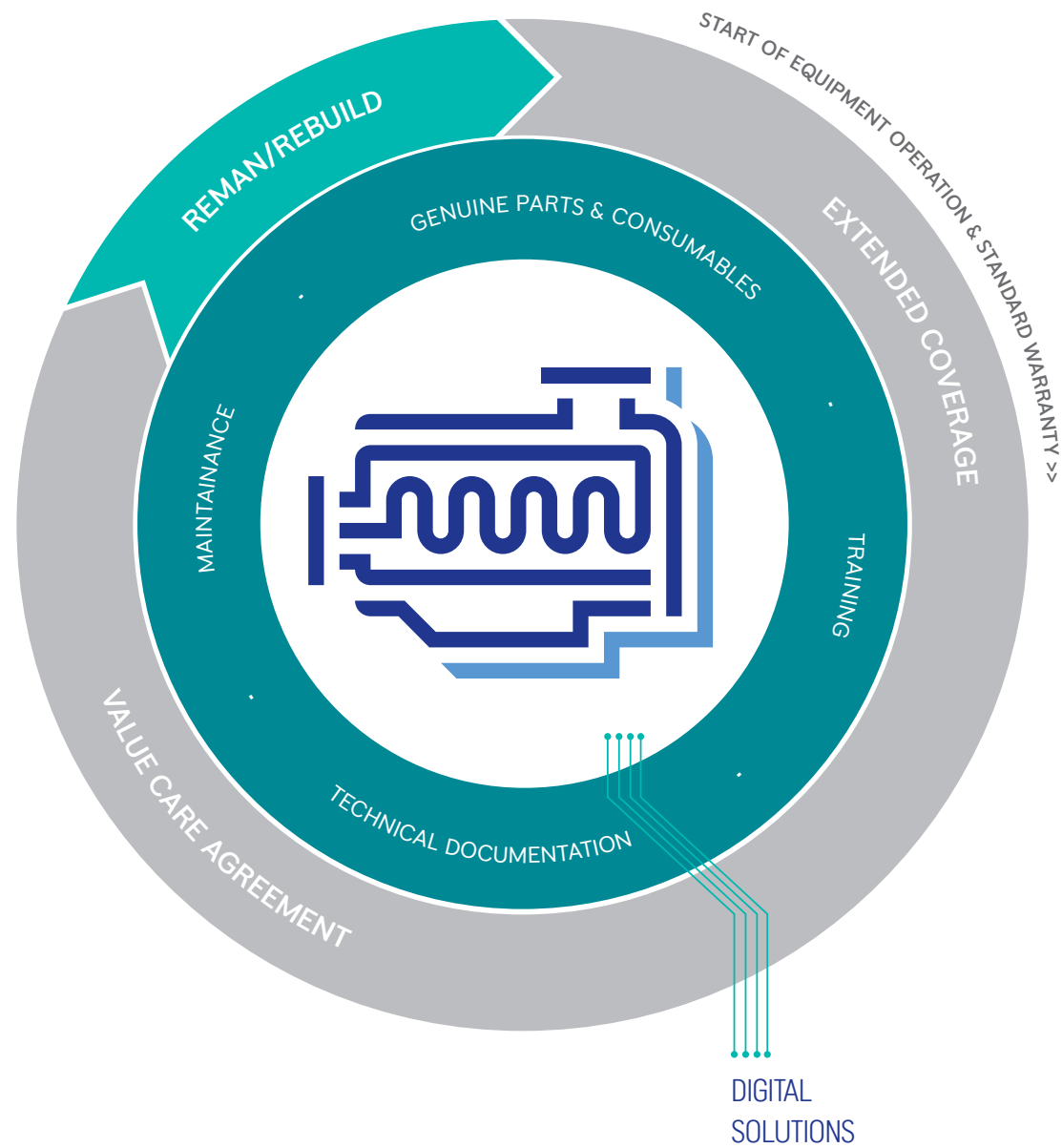

ValueCare Agreements help you:

Increase operational uptime

Guarantee parts availability and service quality

Predict equipment-related costs

Optimize maintenance planning

Connect to us, 24/7

Service

SERVICE SOLUTIONS DESIGNED AROUND YOUR PRIORITIES.

ValueCare Agreements wrap around your investment—providing tailored solutions that make it easy to optimize lifecycle costs, maximize uptime and devote more time and resources to your core business.

	Bronze	Silver	Gold
	Ensure parts availability and price stability	Eliminate unexpected maintenance costs	Maximize operational uptime
	<ul style="list-style-type: none"> – Digital connectivity (Go! Connect) and platform access (Go! Manage) – Automated delivery of parts (preventive) at a predefined rate based on operating hours – Preventive maintenance labor options to fit your business needs – Dedicated support for technical issues – Quarterly reporting of completed and upcoming maintenance and costs – Annual on-site engine health check by our technician 	<ul style="list-style-type: none"> – Proactive maintenance planning, troubleshooting and remote engine health monitoring – Fixed pricing per operating hour for maintenance and repairs – Key corrective maintenance components always in-stock at our main warehouses – 24/7 standby service with remote technical support – Quarterly reports, including reliability analysis (mean time between failure) <p><i>Silver also includes all benefits of Bronze level</i></p>	<ul style="list-style-type: none"> – Operational uptime commitment to meet or exceed your availability targets – Regular supervision by local service partner (e.g. monitoring of parts stock, improvements) – 24/7 emergency assistance with on-site support – Monthly reports, including availability and average repair times – Asset health monitoring – Annual performance meetings and trend analysis with us to address technical updates, engine fleet data, operational optimization and more <p><i>Gold also includes all benefits of Silver & Bronze levels</i></p>



